



ENG

PAD 14 / STAND C08

2025

W
A
T
H
V
E
N
E
S

Q
U
E
R
E
O

AUTOMATIC VISES

GRIPPERS

INTERFACE FACE

ZERO POINT PLATE

ZERO POINT UNIT



WWW.GERARDI.IT

EXPIRATION ON 31 JULY 2025

COMPACT GRIP VISES

Self centering vises with reversible jaws - Ideal for 5 axis machining centres

ART. 650



Std Equipment: 1 box wrench Art.375, 1 workstop Art.370EM, 1 pair of self-centering key-nuts Art.297, 2 positioning key-nuts Art.650G T slot 16 mm, 1 Art.650F slide locking plate

+ Magnetic Workstop Art. 370EM

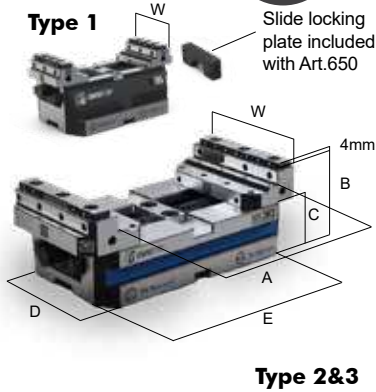

Type	Max opening A	Jaw width W	Jaw Height B	Base Length D	Code	LIST PRICE €	Kg	Cod.	LIST PRICE €	SPECIAL PRICE €	
1 12kN	50	54	65	45	79,9	80	1,9	7.65.01080	777	649	
		94				120		7.65.01120	897	749	
		134				160		7.65.01160	1.015	849	
2 22kN	88	96	65	38	89,9	120	3,6	7.65.02120	955	749	
		136				160		7.65.02160	1.075	849	
		176				200		7.65.02200	1.194	949	
3 32kN	123	216	89	57	124,9	240	5,8	7.65.02240	1.314	1.049	
		260				160		9,1	7.65.03160	1.552	1.199
		283				210		10,9	7.65.03210	1.790	1.299
		310				260		12,8	7.65.03260	2.029	1.399
		333				310		14,8	7.65.03310	2.387	1.649
			360	17	7.65.03360	2.625	1.849				

ART. 651H

Aluminum riser for CompactGrip vises



REDUCTION UP TO 20%

* Savings on Riser only if purchased with the vise

PYRAMIDAL SUPPORT FOR 5TH AXIS CENTRES - INCLUDED MOUNTED & ALIGNED VISES

ART. 643H



Standard equipment: 12 Vise holding clamps Art.298 CGR, 1 Eyebolt, 1 Centering pin, Pair of keynuts Art.297

+ MOUNTING & ALIGNEMENT INCLUDED

Aluminum pyramidal support, it permits the simultaneous mounting of 3 CompactGrip vises thus increasing the working space and allowing the contemporary machining of multiple workpieces.

Type	Height	Cod.	LIST PRICE €
1 (Ø200)	170	7.64.3H100	1.763
2 (Ø308)	136	7.64.3H200	2.157
3 (Ø360)	190	7.64.3H300	2.314

KIT #1

Art. 643H + N°3 Art.650 T.1x120



Cod.	LIST PRICE €	SPECIAL PRICE €
6501120-G11-643H1-60	4.373	3.400

KIT #2

Art. 643H + N°3 Art.650 T.2x200

* Check the machine spindle turning



Cod.	LIST PRICE €	SPECIAL PRICE €
6502200-G11-643H2-30/45	5.571	4.200

KIT #3

Art. 643H + N°3 Art.650 T.3x210

* Check the machine spindle turning



Cod.	LIST PRICE €	SPECIAL PRICE €
6503210-G11-643H3-45	7.525	5.300

MAXIGRIP VISES

ART. 685

Slide locking plate included with Art.685

ART. 685

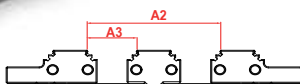
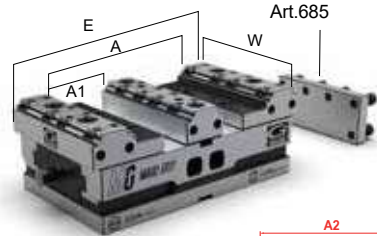

MaxiGrip vise - 3 clamping in 1 - Self-Centering, Double and Single

Type	kN	A	A1	A2	A3	W	E	Kg	Cod.	LIST PRICE €	SPECIAL PRICE €
4x270	41	200	83	104	35	158	270	28,5	76854270	2.920	2.299
4x420		344	155	248	107					420	40

MaxiGrip vise - Only Self-centering

Type	kN	A	A1	A2	A3	W	E	Kg	Cod.	LIST PRICE €	SPECIAL PRICE €
4x270	41	200	-	104	-	158	270	25	76844270	2.500	1.999
4x420		344	-	248	-					420	36



You find this Icon when

JUST ONE VISE HAS 3 DIFFERENT CLAMPING POSSIBILITIES



SELF-CENTERING

2 movable jaws clamp the workpiece by simultaneously moving toward the center



DOUBLE

Clamping of two workpieces through the use of the intermediate jaw.



SINGLE

Clamping of 1 workpiece using a jaw as mobile and the opposite as fixed.

QUICK CHANGE PLATES

Quick change plates for compactgrip vises - Ideal for 5 axis machines



ART.660

Mechanical quick change rectangular plate

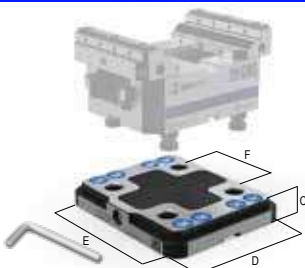

Standard equipment: 4 Pull-studs Art.660B

Type	C	D	E	Kg	Cod.	LIST PRICE €	SPECIAL PRICE €
1-2 (F=52)	27	116	150	3	9.66.05200	787	549
3 (F=96)	27	156	190	5,2	9.66.09600	1.133	849

ART.661

Mechanical quick change round plate

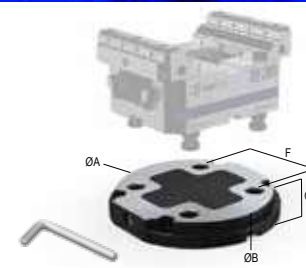

Standard equipment: 4 Pull-studs Art.660B

Type	ØA	ØB	C	Kg	Cod.	LIST PRICE €	SPECIAL PRICE €
1-2 (F=52)	156	120	27	3	9.66.15200	754	549
3 (F=96)	196	175	27	5,2	9.66.19600	1.102	849

ART.660S

Mechanical quick change hardened with machineable part holes free rectangular plate

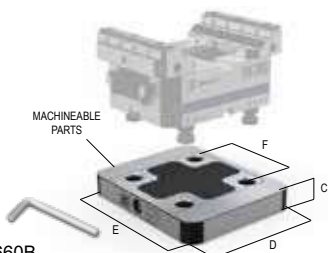

Customization Excluded

Standard equipment: 4 Pull-studs Art.660B

Type	C	D	E	Kg	Cod.	LIST PRICE €	SPECIAL PRICE €
1-2 (F=52)	27	126	150	3	9.66.0S520	638	449
3 (F=96)	27	156	190	5,2	9.66.0S960	870	649

ART.661S

Also with bar passage

Mechanical quick change hardened with machineable part holes free round plate

Available Quick Change Plates for any kind of Rotary Plates or 4° Axis

Customization Excluded

Standard equipment: 4 Pull-studs Art.660B

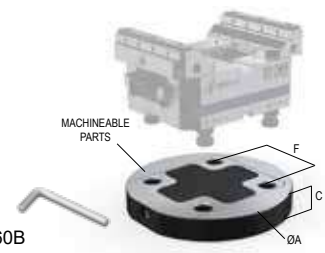

Type	ØA	C	Kg	Cod.	LIST PRICE €	SPECIAL PRICE €
1-2 (F=52)	156	27	3,8	9.66.1S5200	696	449
3 (F=96)	196	27	6	9.66.1S9600	1.159	649
	250	24	10	9.66.1S960-250	1.647	1.450
	300	24	15	9.66.1S960-300	1.750	1.550

ART.660R

Mechanical quick change rectangular reduction plate

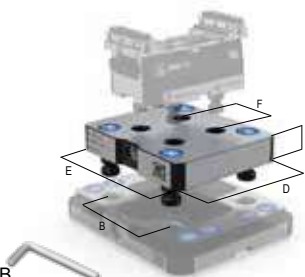

Standard equipment: 4 Pull-studs Art.660B

Type	B	C	D	E	Kg	Cod.	LIST PRICE €	SPECIAL PRICE €
F = 52	96	27	126	150	3,75	9.66.0R210	696	449

ART.661R

Round reduction plate



Standard equipment: 4 Pull-studs Art.660B

Type	A	B	C	Kg	Cod.	LIST PRICE €	SPECIAL PRICE €
F = 52	158	96	27	3,75	9.66.1R210	870	449

ART.660B

Quick change plate pull studs



For type 1-2 plates

For type 3 plates

Type	Code	LIST PRICE CAD. €
1 - 2	9.66.0B100	31
3	9.66.0B200	33

ART.661H

Aluminium base riser for quick-change plate, can be mounted with brackets or via Zero Point



ART.661S

Also with bar passage

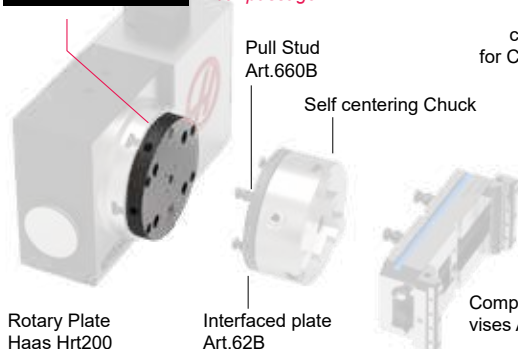

Rotary Plate Haas Hrt200

Interfaced plate Art.62B

CompactGrip vises Art.650 T.3

EXAMPLE Mounting of a round quick change plate for CompactGrip vises

STANDARD FLEX VISES

Innovative comb system for quick pull-down jaw plates change - Ideal for vertical machining centres

ART.1A

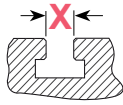

StandardFLEX series precision modular vise

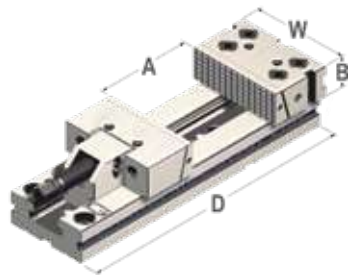

Std Equipment: 1 workstop, 2 positioning key-nuts for 16 mm slot, 2 inserts Art. 291, 1 box wrench, 1 "T" wrench

+ 4 Holding Clamps Art.298

Type	Max opening A	Jaw width W	Jaw Height B	Base Length D	Code	LIST PRICE €	SPECIAL PRICE €
2 25kN	150	121 mm	38	345	1.1A.20000	925	789
	200	146 mm	48	420	1.1A.32000	1.112	839
3 30kN	300	171 mm	58	520	1.1A.33000	1.283	949
	200			455	1.1A.42000	1.414	1.189
	300			555	1.1A.43000	1.555	1.239
4 30kN	400			655	1.1A.44000	1.696	1.339
	200			495	1.1A.52000	1.846	1.489
	300	196 mm	63	595	1.1A.53000	2.210	1.789
5 40kN	400			695	1.1A.54000	2.582	2.039

REDUCTION UP TO 20%

* When bought with a complete vise

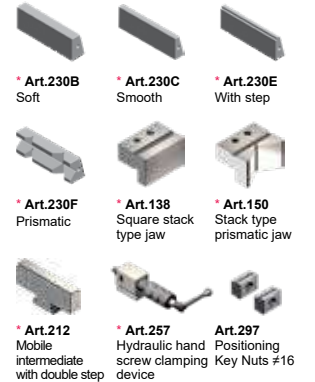

EXTRA LONG VISES

Vises with the extra large base dimension, much longer than std vise - Ideal for vertical machining centres

ART.21

(Single Clamping)

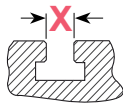

XL modular vise with standard dotation

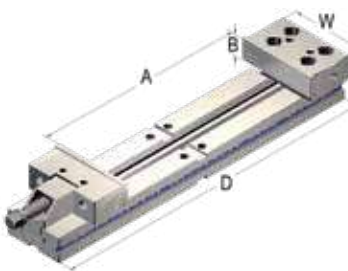

Std Equipment: 1 workstop, 2 positioning key-nuts for 16 mm slot, 2 inserts Art. 291, 1 box wrench, 1 "T" wrench

+ 6 Holding clamps Art. 298

Type	Max opening A	Jaw width W	Jaw Height B	Base Length D	Code	LIST PRICE €	LIST PRICE €	SPECIAL PRICE €
2 25kN	320	125 mm	40	520	17	2.21.23200	1.147	800
	360	150 mm	50	580	32	2.21.33600	1.425	1.000
3 30kN	460			680	35	2.21.34600	1.578	1.150
	500			766	52	2.21.45000	1.828	1.350
	600	175 mm	60	866	56	2.21.46000	1.990	1.450
4 30kN	700			966	61	2.21.47000	2.159	1.550

REDUCTION UP TO 20%

* When bought with a complete vise

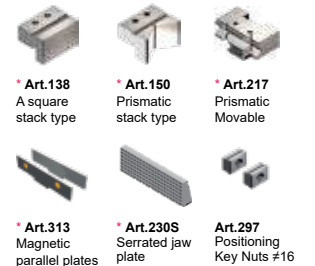

PARALLEL MAGNETIC PLATES

Wide range of heights available on page 4.27 - General price list w17

FOR VISES STANDARD & STANDARDFLEX ART.1 e ART.1A

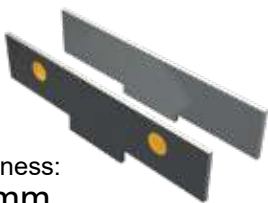

Thickness: 2,8mm

ART.414

Also Available Universal Parallel magnetic plates

ART.310

Type	Pair of guided parallels magnetic plates	LIST PRICE EACH €
1	73	73
2	93	93
3	116	116
4	136	136
5	155	155
6	176	176

Price each in case of set purchase

6 pairs of parallel bars (Art.313-313R)

PRICE EACH €	KIT PRICE €
50	300
65	390
75	450
90	540
100	600
120	720

ART.311

Price each in case of set purchase

10 pairs of parallel bars (Art.313-313R)

PRICE EACH €	KIT PRICE €
-	-
-	-
70	700
80	800
90	900
100	1.000

REDUCTION UP TO 40%



AUTOMATION KITS

Unit with pneumatic control and single effect cylinder - Ideal for vertical machining centres

FOR VISES STANDARD & STANDARDFLEX ART. 1 and ART.1A

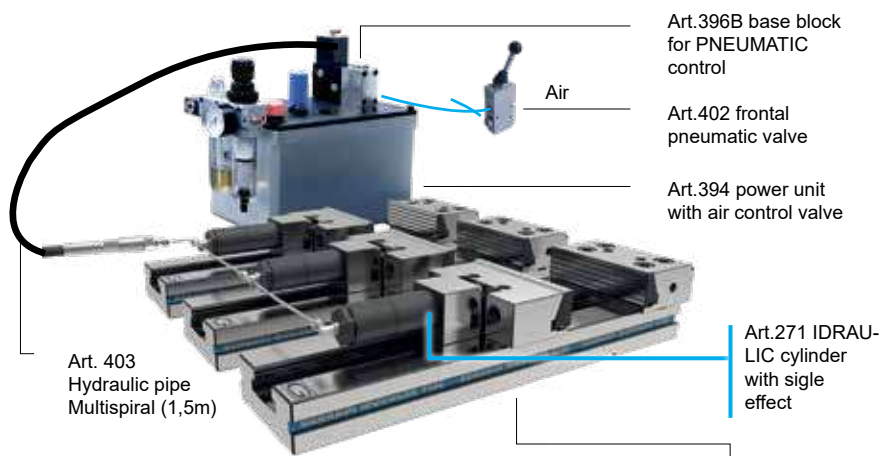

Also available units with solenoid valves electromagnetics for CNC

WISE NOT INCLUDED

WISE NOT INCLUDED

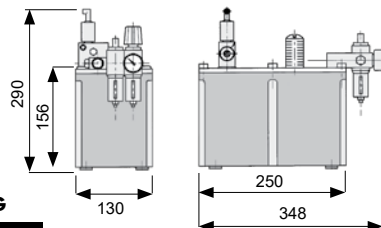

N°1 CLAMPING

ART.392

Type	Stroke Art.271	Code	LIST PRICE €	SPECIAL PRICE €
2	26	4.39.22000	1.872	1.499
3		4.39.23000	1.884	1.499
4		4.39.24000	1.917	1.499
5	40	4.39.25000	2.109	1.599

SIMULTANEOUS VISES CLAMPING KIT

*Art.405H Suitable galvanized steel pipe Ø6 (Not included) (m1,0) Codice: 4.40.5H000

ART.392/2

(Art.271- 394 - 402 - 403)
N°2 SYMULTANEOUSLY CLAMPING
Art.392 + N°1 Art.271

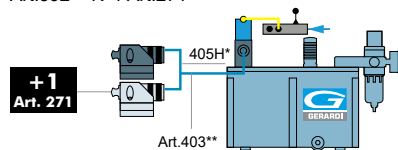

Type	Cod.	LIST PRICE €	SPECIAL PRICE €
2	4.39.22002	2.255	1.799
3	4.39.23002	2.277	1.799
4	4.39.24002	2.345	1.799
5	4.39.25002	2.725	2.099

ART.392/3

N°3 SYMULTANEOUSLY CLAMPING
Art.392 + N°2 Art.271

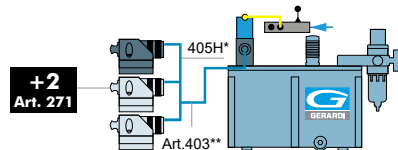

Type	Cod.	LIST PRICE €	SPECIAL PRICE €
2	4.39.22003	2.634	2.099
3	4.39.23003	2.667	2.099
4	4.39.24003	2.767	2.099
5	4.39.25003	3.341	2.499

ART.392/4

N°4 SYMULTANEOUSLY CLAMPING
Art.392 + N°3 Art.271

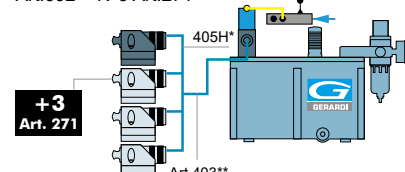

Type	Cod.	LIST PRICE €	SPECIAL PRICE €
2	4.39.22004	3.017	2.399
3	4.39.23004	3.059	2.399
4	4.39.24004	3.196	2.399
5	4.39.25004	3.958	2.999

INDEPENDENT CLAMPING GROUP KIT

*Art.403 (Compreso) Hydraulic pipe Multispiral 760bar complete with rapid connection Art. 270A (m 1,5) Codice: 4.40.30000

ART.392A/2

(Art.271- 394 - 402 - 403)
N°2 SYMULTANEOUSLY CLAMPING
Art.392 + N°1 Art.407B

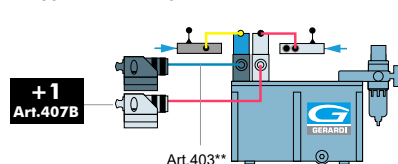

Type	Cod.	LIST PRICE €	SPECIAL PRICE €
2	4.39.2A202	3.063	2.399
3	4.39.2A302	3.083	2.399
4	4.39.2A402	3.161	2.399
5	4.39.2A502	3.639	2.799

ART.392A/3

N°3 SYMULTANEOUSLY CLAMPING
Art.392 + N°2 Art.407B

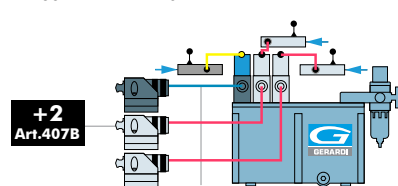

Type	Cod.	LIST PRICE €	SPECIAL PRICE €
2	4.39.2A203	3.564	2.799
3	4.39.2A303	3.596	2.799
4	4.39.2A403	3.695	2.799
5	4.39.2A503	4.247	3.299

ART.392A/4

N°4 SYMULTANEOUSLY CLAMPING
Art.392 + N°3 Art.407B

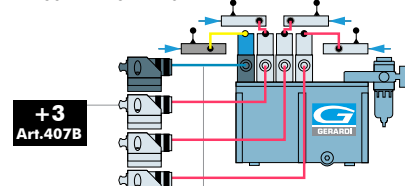

Type	Cod.	LIST PRICE €	SPECIAL PRICE €
2	4.39.2A204	4.413	3.599
3	4.39.2A304	4.455	3.599
4	4.39.2A404	4.584	3.599
5	4.39.2A504	5.319	4.199

FMS VISES

For single, double and self-centering clamping - Ideal for vertical & horizontal machines

ART.855

Base Body 3 in 1



ART.855A

Base Body
Self-Centering Only

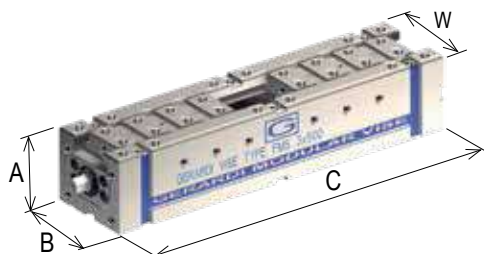

Type W	Base eight A	Base width B	Base length C	Code	LIST PRICE €	Cod.	LIST PRICE €
2 (94mm) 25kN	90	95	400	5.85.52400	1.365	5.85.5240A	1.447
			500	5.85.52500	1.848	5.85.5250A	1.947
			600	5.85.52600	2.041	5.85.5260A	2.114
3 (124mm) 30kN	100	125	500	5.85.53500	1.773	5.85.5350A	1.864
			600	5.85.53600	2.452	5.85.5360A	2.559
4 (144mm) 30kN	120	145	600	5.85.54600	2.258	5.85.5460A	2.337

ART.855

ART.855A

COMPOSE YOUR VISE WITH THE HUNDREDS OF JAWS AVAILABLE

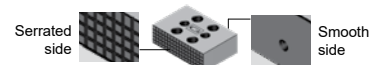

DOUBLE CLAMPING CONFIGURATION

ART.860

Double vises with serrated jaws

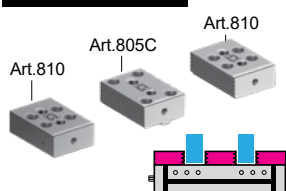

Type	Cod.	LIST PRICE €	SPECIAL PRICE €
2	5.86.02400	1.794	1.400
	5.86.02500	2.281	1.800
	5.86.02600	2.471	1.950
3	5.86.03500	2.264	1.800
	5.86.03600	2.941	2.300
4	5.86.04600	2.908	2.300

ART.863

Double vise with step jaws

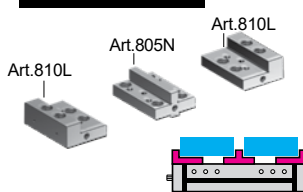

Type	Cod.	LIST PRICE €	SPECIAL PRICE €
2	5.86.32400	1.952	1.550
	5.86.32500	2.436	1.900
	5.86.32600	2.628	2.100
3	5.86.33500	2.420	1.900
	5.86.33600	3.098	2.450
4	5.86.34600	3.104	2.450

ART.865

Double vise with quick change pull down jaws (comb system)

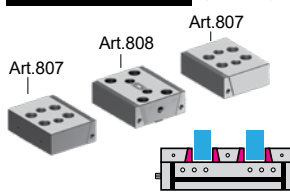

Type	Cod.	LIST PRICE €	SPECIAL PRICE €
2	5.86.52400	2.120	1.700
	5.86.52500	2.604	2.100
	5.86.52600	2.798	2.200
3	5.86.53500	2.735	2.200
	5.86.53600	3.418	2.700
4	5.86.54600	3.540	2.800

ART.866

Double vise with floating step jaws (3x5)

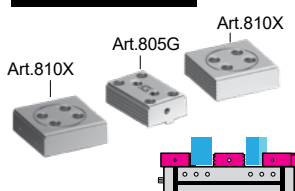

Type	Cod.	LIST PRICE €	SPECIAL PRICE €
2	5.86.62400	2.242	1.800
	5.86.62500	2.728	2.200
	5.86.62600	2.918	2.300
3	5.86.63500	2.761	2.200
	5.86.63600	3.439	2.700
4	5.86.64600	3.391	2.700

ART.867

Double vise with floating step jaws with adjustable inserts

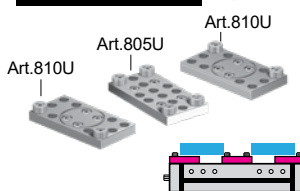

Type	Cod.	LIST PRICE €	SPECIAL PRICE €
2	5.86.72400	2.618	1.999
	5.86.72500	3.048	2.328
	5.86.72600	3.293	2.516
3	5.86.73500	3.171	2.423
	5.86.73600	3.850	2.941
4	5.86.74600	3.874	2.960

* SELF-CENTERING CONFIGURATION ONLY

* For self-centering configuration ONLY, spacer Art.850T included in the price

ART.855A

Base Body -
Self-Centering Only

ART.810

2 Serrated jaws

ART.860A

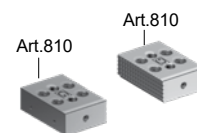

Type	* LIST PRICE €
2	1.647
2	2.135
	2.325
3	2.100
	2.776
4	2.682

ART.855A

Base Body -
Self-Centering Only

ART.810L

2 Step jaws

ART.863A

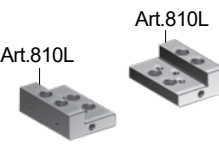

Type	* LIST PRICE €
2	1.722
2	2.206
	2.398
3	2.172
	2.848
4	2.775

ART.855A

Base Body -
Self-Centering Only

ART.807

2 Quick change pull down jaws

ART.865A

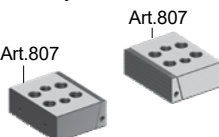

Type	* LIST PRICE €
2	1.846
2	2.330
	2.524
3	2.332
	3.015
4	3.008

ART.855A

Base Body -
Self-Centering Only

ART.814 (n°2)

ART.805V (n°2)

ART.868A



Type	* LIST PRICE €
2	2.113
2	2.578
	2.757
3	2.590
	3.246
4	3.328

ART.855A

Base Body -
Self-Centering Only

ART.810J

2 Prismatic jaws

ART.870A

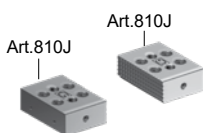
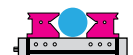

Type	* LIST PRICE €
2	1.882
2	2.367
	2.558
3	2.377
	3.054
4	3.108

IDEAL FOR 5 AXIS MACHINING CENTERS

MULTIFLEX VISES

For multiple clamping from 1 to 19 workpieces of various sizes - Ideal for vertical & horizontal machines



Std Equipment : 1 "T" wrench, 2 positioning keynuts and 4 workstops.
Each vise is supplied for 4 workpieces clamping.

+ 6 holding clamps Art.298

(* Types supplied for 3 workpieces clamping)

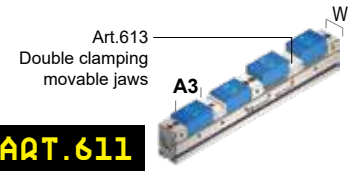
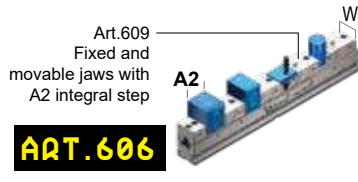
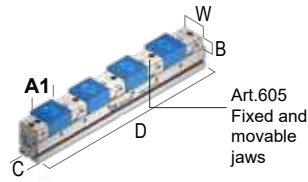

ART.600

ART.600W

ART.606

ART.611

Type	B	C ^{+0.002}	D	W	A1 mm	Cod.	LIST PRICE €	SPECIAL PRICE €	A2 mm	Cod.	LIST PRICE €	SPECIAL PRICE €	A3 mm	Cod.	LIST PRICE €	SPECIAL PRICE €
1 20kN	32/25	50	49	300	4x8	6.60.01300	1.204	749	* 3x19	6.60.61300	1.822	1.200	* 3x21	6.61.11300	1.822	1.200
				400	4x33	6.60.01400	1.308	849	4x23	6.60.61400	1.898	1.300	4x46	6.61.11400	1.898	1.300
				500	4x58	6.60.01500	1.425	949	4x48	6.60.61500	2.013	1.400	4x71	6.61.11500	2.013	1.400
				600	4x83	6.60.01600	1.553	1.049	4x73	6.60.61600	2.141	1.500	4x96	6.61.11600	2.130	1.500
				700	4x108	6.60.01700	1.736	1.149	4x97	6.60.61700	2.327	1.600	4x121	6.61.11700	2.327	1.600
2 30kN	40	75	74	400	4x12	6.60.02400	1.566	1.099	* 3x28	6.60.62400	2.266	1.550	4x34	6.61.12400	2.266	1.550
				500	4x37	6.60.02500	1.681	1.249	4x24	6.60.62500	2.386	1.650	4x59	6.61.12500	2.386	1.650
				600	4x62	6.60.02600	1.811	1.349	4x49	6.60.62600	2.517	1.750	4x84	6.61.12600	2.517	1.750
				700	4x87	6.60.02700	1.940	1.449	4x74	6.60.62700	2.647	1.850	4x109	6.61.12700	2.647	1.850
				800	4x112	6.60.02800	2.114	1.549	4x99	6.60.62800	2.832	1.950	4x134	6.61.12800	2.832	1.950
3 40kN	60	100	99	900	4x137	6.60.02900	2.302	1.749	4x124	6.60.62900	3.021	2.050	4x158,5	6.61.12900	3.021	2.050
				700	4x59	6.60.03700	2.244	1.649	4x44	6.60.63700	3.057	2.150	4x77	6.61.13700	3.057	2.150
				800	4x84	6.60.03800	2.428	1.749	4x69	6.60.63800	3.245	2.250	4x102	6.61.13800	3.245	2.250
				900	4x109	6.60.03900	2.619	1.949	4x94	6.60.63900	3.431	2.450	4x127	6.61.13900	3.431	2.450
				1000	4x134	6.60.03100	2.869	2.149	4x119	6.60.63100	3.682	2.650	4x152	6.61.13100	3.682	2.650

FOR MAGNETIC PARALLEL PLATES AND PARALLEL JAW PLATES

Art.616

Pair of magnetic parallel plates for Art. 600



REDUCTION UP TO **20%**

When bought with a complete vise



Art.610E

Parallel jaw plate for Art.606

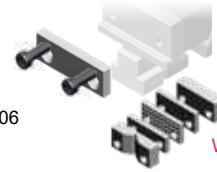

REDUCTION UP TO **20%**

When bought with a complete vise

MULTITASKING VISES

Self-centering and eccentric vises - Ideal for 5 axis machining centres

ART.640

! Possible request of 2 Art.645T jaws instead Art.645E

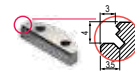

Standard equipment : 1 workstop, 1 exagonal wrench, pair of positioning key-nuts Art.297, 1 straight pin Art.640P

Type	1	2	3x166	3x266
Cod.	6.64.01000	6.64.02000	7.64.03166	7.64.03266
LIST PRICE €	1.858	2.285	2.658	2.785
SPECIAL PRICE €	1.049	1.249	1.899	1.999

ART.641H

Compatible

Type	1	2	3x166	3x266
Cod.	7.64.1H100AL /100	7.64.1H200AL /100	7.64.1H3166AL /100	7.64.1H3266AL /100
LIST PRICE €	640	753	769	1.167
SPECIAL PRICE €	400	450	600	900

Simple riser for Art.640 vise MOUNTING INCLUDED

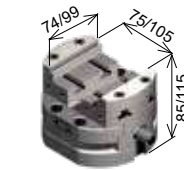

Steel risers with zero point for Art.640 for quick change. Standard equipment : 1 pull-stud Art.10S / 11S 1 teflon cap with O-ring Art.9, 1 positioning pin Art.640P, 1 shoulder calibrated screw Art.79



ART.645B

Soft Jaw

Type	Cod.	LIST PRICE €	SPECIAL PRICE €
1	6.64.5B100	102	77
2	6.64.5B200	122	93
3	6.64.5B300	159	121

ART.645C

Smooth Jaw

Type	Cod.	LIST PRICE €	SPECIAL PRICE €
1	6.64.5C100	102	77
2	6.64.5C200	122	93
3	6.64.5C300	159	121

ART.645D

Serrated Jaw

Type	Cod.	LIST PRICE €	SPECIAL PRICE €
1	6.64.5D100	102	77
2	6.64.5D200	122	93
3	6.64.5D300	159	121

ART.645E

Step Jaw

Type	Cod.	LIST PRICE €	SPECIAL PRICE €
1	6.64.5E100	115	87
2	6.64.5E200	134	102
3	6.64.5E300	171	130

ART.645F

Prismatic Jaw

Type	Cod.	LIST PRICE €	SPECIAL PRICE €
1	6.64.5F100	129	98
2	6.64.5F200	146	111
3	6.64.5F300	185	141

ART.645T

Grip Jaw (Supplied on request)

Type	Cod.	LIST PRICE €	SPECIAL PRICE €
1	6.64.5T100	129	98
2	6.64.5T200	146	111
3	6.64.5T300	185	141

TOMBSTONES

Solid cast iron cast with double stress relieving heat treatment - Ideal for orizontal machining centres made in italy

STANDARD JAPANESE

BASE/HEIGHT REDUCTION: € 220

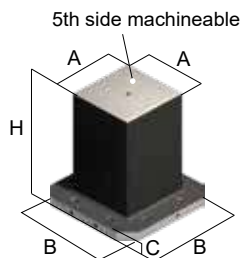

AQT.S3

B

Cod.	A	B	C	D	H	Kg	LIST PRICE €	SPECIAL PRICE €
8.53.B00080	260	400	45	-	550	197	1.853	1.550
8.53.B00081	260	400	45	-	660	228	2.139	1.690
8.53.B00100	260	500	45	-	650	255	2.417	2.000
8.53.B00105	260	500	45	-	750	284	2.505	2.000
8.53.B00115	310	500	45	-	900	383	3.551	2.700
8.53.B00171	360	500	45	-	700	356	3.328	2.500
8.53.B00180	360	630	45	-	820	452	4.217	3.200
*8.53.B00211	510	630	45	-	860	61	5.858	3.850

* Only for pallets with "T" slots

AQT.S3

B2 PLUS

Cod.	Kg	LIST PRICE €	SPECIAL PRICE €
8.53.B20080	182	2.361	1.950
8.53.B20081	204	2.680	2.050
8.53.B20100	238	3.027	2.400
8.53.B20105	254	3.138	2.500
8.53.B20115	354	4.311	3.300
8.53.B20171	326	4.041	3.050
8.53.B20180	427	5.277	4.200
8.53.B20211	593	7.113	4.350

A One integral G30 cast iron casting milled with double stressrelieving heat treatment. Wall thickness 43-45mm. Tolerance +12 / -5 mm

B Rough casting with machined and hand scraped base face for direct clamping on Japanese standard pallet. Base with 4 precision holes Ø20F7 and bottom threads M16 with precise pitch dimensions for the use of our Zero Point or to be interface with other pallets or head plates. Ready for installation and to be machined for reset with machine axis. Tolerance +12 / -5 mm

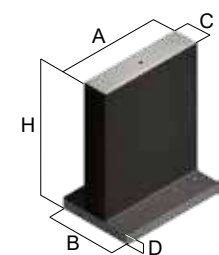

AQT.S5

B

Cod.	A	B	C	D	H	Kg	LIST PRICE €	SPECIAL PRICE €
8.55.B00052	410	400	160	50	660	244	2.345	1.800
8.55.B00053	510	500	160	50	700	331	3.131	2.400
8.55.B00054	510	500	210	55	600	316	3.042	2.300
8.55.B00170	640	450	160	55	820	460	4.347	3.200
8.55.B00172	640	630	210	55	850	545	5.178	3.540
8.55.B00190	810	450	160	65	800	604	5.805	4.040

AQT.S5

B2 PLUS

Cod.	Kg	LIST PRICE €	SPECIAL PRICE €
8.55.B20052	206	2.846	2.150
8.55.B20053	303	3.801	2.900
8.55.B20054	301	3.693	2.800
8.55.B20170	433	5.278	4.000
8.55.B20172	520	6.288	4.500
8.55.B20190	782	7.048	4.900

C Cube completely finished with wall thickness roughly 38-40mm. Tolerance ± 0,02 mm

B2 PLUS 1mm overstock on each side. Ready for installation and to be machined for reset with machine axis.

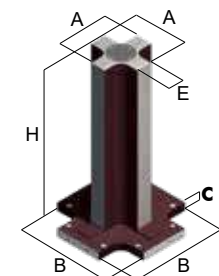

AQT.S7

B

Cod.	A	B	C	D	H	Kg	LIST PRICE €	SPECIAL PRICE €
8.57.B00100	210	500	50	80	750	157	1.715	1.550
8.57.B00110	280	500	50	80	850	235	2.126	1.950
8.57.B00120	240	500	50	110	850	218	2.049	1.850
8.57.B00130	310	500	50	150	850	269	2.466	2.050
8.57.B00140	310	630	50	150	950	327	2.790	2.450

AQT.S7

B2 PLUS

Cod.	Kg	LIST PRICE €	SPECIAL PRICE €
8.57.B20100	155	2.075	1.850
8.57.B20110	241	2.608	2.300
8.57.B20120	216	2.556	2.250
8.57.B20130	232	2.974	2.550
8.57.B20140	325	3.293	2.650

E Integral cube with calibrated holes and solid threads. Tolerance ± 0,02 mm

F Integral cube with hardened bushing 100 Cr6 and stainless steel helicoils. Tolerance ± 0,02mm

INTEGRAL VISE-CUBE WITH BASE

AQT.S3B1

Light Cube Finished Base



REDUCTION UP TO **20%**

AQT.S5B1

2 sides tombstones light Finished Base



REDUCTION UP TO **20%**

A	B	C	E	H	Kg	Cod.	LIST PRICE €	SPECIAL PRICE €
210	400	45	25	750	167	8.53.B10055	1.853	1.500
260	400	45	25	850	229	8.53.B10085	2.235	1.800
260	500	45	25	750	234	8.53.B10105	2.439	1.950
360	500	50	30	900	400	8.53.B10182	3.453	2.700
360	630	45	30	950	468	8.53.B10185	4.135	3.250
460	630	45	35	950	634	8.53.B10205	5.161	4.250

E= Wall tickness

A	B	C	D	E	H	Kg	Cod.	LIST PRICE €	SPECIAL PRICE €
410	400	110	55	25	750	193	8.55.B10045	2.111	1.700
410	400	160	55	25	850	239	8.55.B10050	2.343	1.900
510	500	160	55	25	750	277	8.55.B10053	2.757	2.200
510	500	210	55	30	900	402	8.55.B10085	3.531	2.800
640	630	210	55	30	950	553	8.55.B10172	4.753	3.700

E= Wall tickness

ZERO POINT UNITS & PLATES

Set up times reduced of 90%, repeatability within 0,005 mm - Ideal for vertical & horizontal machining centres

THE CLASSIC MULTIPLE PNEUMATIC



ART.664		WITH FLANGE				
Type	Cod.	kN	Double Effect kN	LIST PRICE €	SPECIAL PRICE €	
1	9.66.41000	5,4	NOT AVAILABLE	632	499	
2	9.66.42000	10		951	599	
3	9.66.43000	16		1.194	999	

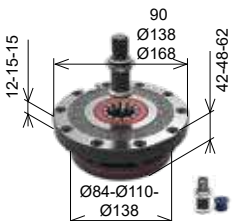

ART.665		BUILT-IN				
Type	Cod.	kN	Double Effect kN	LIST PRICE €	SPECIAL PRICE €	
1	9.66.51000	5,4	NOT AVAILABLE	509	399	
2	9.66.52000	10		826	499	
3	9.66.53000	16		1.075	899	

THE HERMETIC SINGLE PNEUMATIC

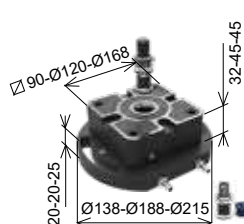

ART.664S		WITH FLANGE		DOUBLE EFFECT AIR+SPRINGS		
Type	Cod.	kN	Double Effect kN	LIST PRICE €	SPECIAL PRICE €	
1	9.66.4S100	5,4	12,7	732	599	
2	9.66.4S200	10	27	1.037	699	
3	9.66.4S300	16	40	1.194	999	

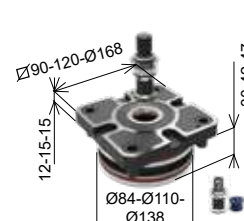

ART.665S		BUILT-IN		DOUBLE EFFECT AIR+SPRINGS		
Type	Cod.	kN	Double Effect kN	LIST PRICE €	SPECIAL PRICE €	
1	9.66.5S100	5,4	12,7	610	499	
2	9.66.5S200	10	27	914	599	
3	9.66.5S300	16	40	1.075	899	

Standard Equipment: 1 pull-stud Art.11A, 1 Teflon cup with O-Ring Art.9

Clamping force 5 + 40 kN / Holding force more than 60 kN / Pneumatic release 6 + 14 bar / Axial and radial compensation thanks to elastic integral collet / Double pull-stud centering for Max rigidity / Air cleaning / Only for SINGLE ZERO POINT (S version): 4 KEYWAYS and DOUBLE EFFECT FUNCTION

PNEUMATIC ZERO POINT KIT INTERFACED BASE PLATES

KIT #1 E #2 POSITIONING & LOCKING INCLUDED

KIT #3 E #4 STANDARD POSITIONING & LOCKING INCLUDED, SPECIFIC LOCKING **EXTRA***

KIT #1 VERTICAL CNC

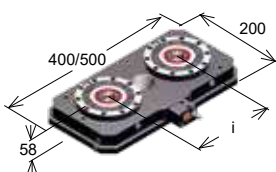

Art.81P BASE PLATE	LIST PRICE €	SPECIAL PRICE €
200x400 (i=200)	2.724	1.749
200x500 (i=250)	2.793	1.849

KIT #2 HORIZONTAL CNC

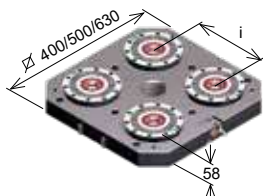

Art.80P BASE PLATE	LIST PRICE €	SPECIAL PRICE €
400x400 (i=200)	4.880	3.299
500x500 (i=250)	5.107	3.499
630x630 (i=300)	5.595	3.999

KIT #3 VERTICAL CNC

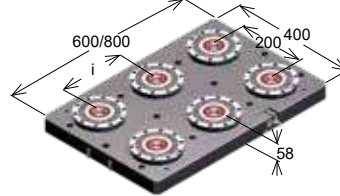

Art.81P BASE PLATE	LIST PRICE €	SPECIAL PRICE €
400x600 (i=200)	7.035	4.699
400x800 (i=300)	7.332	4.899

KIT #4 5TH AXIS CNC

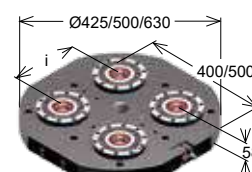

Art.82P ROUND BASE PLATE	LIST PRICE €	SPECIAL PRICE €
Ø425 (i=200)	5.107	3.399
Ø500 (i=250)	5.085	3.499
Ø630 (i=300)	5.674	3.999

INTERFACE PLATES FOR ZERO POINT BASE PLATES

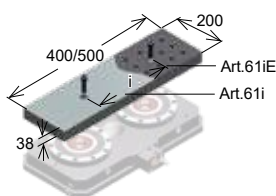

Art.61iC SMOOTH	LIST PRICE €	SPECIAL PRICE €
200x400 (i=200)	936	599
200x500 (i=250)	1.006	649

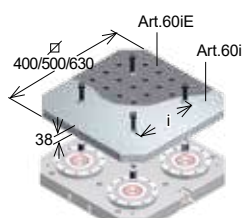

Art.60iC SMOOTH	LIST PRICE €	SPECIAL PRICE €
400x400 (i=200)	1.146	863
500x500 (i=250)	1.380	1.039
630x630 (i=300)	1.730	1.303

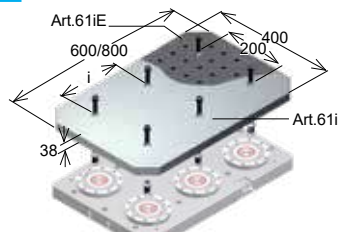

Art.61iE INTEGRAL GRID	LIST PRICE €	SPECIAL PRICE €
400x600 (i=200)	1.753	1.320
400x800 (i=300)	2.337	1.760

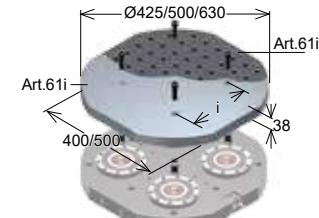

Art.62iE INTEGRAL GRID	LIST PRICE €	SPECIAL PRICE €
Ø425 (i=200)	1.228	924
Ø500 (i=250)	1.402	1.056
Ø630 (i=300)	1.636	1.232

Art.61iE INTEGRAL GRID	LIST PRICE €	SPECIAL PRICE €
200x400 (i=200)	1.135	649
200x500 (i=250)	1.250	749

Art.60iE INTEGRAL GRID	LIST PRICE €	SPECIAL PRICE €
400x400 (i=200)	1.505	1.040
500x500 (i=250)	1.968	1.360
630x630 (i=300)	3.090	2.136

Art.61iE INTEGRAL GRID	LIST PRICE €	SPECIAL PRICE €
400x600 (i=200)	2.083	1.440
400x800 (i=300)	2.962	2.048

Art.62iE INTEGRAL GRID	LIST PRICE €	SPECIAL PRICE €
Ø425 (i=200)	1.505	1.040
Ø500 (i=250)	1.921	1.328
Ø630 (i=300)	2.569	1.776

GRIP MATIC VISES

Hydraulic or pneumatic vise double effect - Ideal for 5 axis machining centres

Art.670



Standard equipment: - 4x Calibrated screws (Art.83) - 2 Niplon o 2 Art.PN04 - No return valve (Art.PN16)

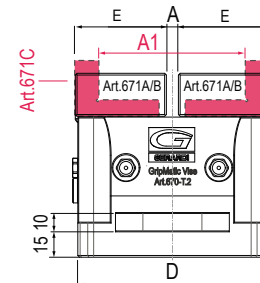
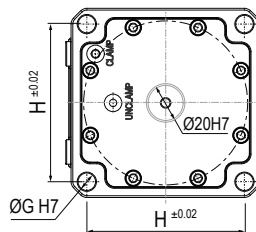
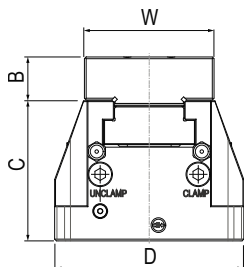

Vise base pneumatic or Hydraulic, ideal for 5 axis machining centres.

Type	Jaw width W	Min opening A	Max opening A1	Vise height C+B	Base height C	Base length D	Jaw length E	Pitch centering and fixing holes H	ART.670 PNEUMATIC		ART.670 HYDRAULIC		LIST PRICE €	SPECIAL PRICE €	
									Air pressure	Clamping force	Pressure	Clamping force			
2	74	6,4	88,9	105	80	106	52	90	7 kN	7.67.0PN20	30BAR	19 kN	7.67.0ID20	1.790	1.400
3	99	8,5	130,2	135	105	166	78	140	14,4 kN	7.67.0PN30	30BAR	37,5 kN	7.67.0ID30	2.387	1.850
4	124	12	162	165	130	206	96	170	16,9 kN	7.67.0PN40	25 BAR	47 kN	7.67.0ID40	3.162	2.400



Art.671A Soft Jaw



Art.671B Soft narrow jaw



Art.671C Jaw for narrow width standard jaw plates



Art.243 Hardened grooved straight jaw plate



Art.245 Hardened smooth straight jaw plate



Art.247G Straight plate with GRIP inserts

INTERFACED PLATE FOR GRIP MATIC VISES - IDEAL FOR 5 AXIS MACHINING CENTRES

Art.670CP SEMI-AUTOMATIC

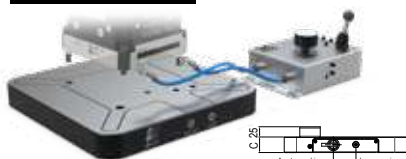

Interface plate for GripMatic vise Art.670PN semi-automatic quick coupling air input and manual system control through a selector.

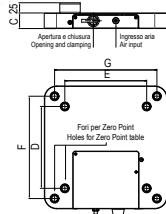
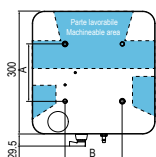

Type	Holes pitch A	Holes pitch B	Plate height C	Pitch holes (Zero Point) D	Pitch holes (Zero Point) E	Pitch holes (Zero Point) F	Pitch holes (Zero Point) G	Air pressure	Clamping force	Code	LIST PRICE €
2	90	90	38	200	200	250	250	Max 10BAR	7 kN	7.67.0CP20	2.271
3	140	140	38	200	200	250	250		14,4 kN	7.67.0CP30	
4	170	170	38	200	200	250	250		16,9 kN	7.67.0CP40	

Art.670AP FULLY AUTOMATIC



Interface plate for GripMatic vise Art.670PN automatic with air input through the machine table and possible to be controlled directly by the CNC. This plate can be fully tailored according the characteristics of the machine (workpiece positioning check and cleanliness).

* Minimum price, PERSONALIZATION INCLUDED

100% Customizable Plate

Type	Air pressure	Clamping force	ART.670 Pneumatic Code	LIST PRICE €*
2	Max 10BAR	7 kN	7.67.0AP20	2.497
3		14,4 kN	7.67.0AP30	
4		16,9 kN	7.67.0AP40	

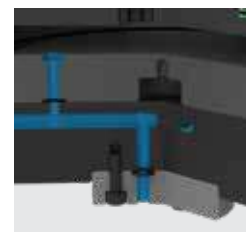

DUODUX CHUCKS

Double guide self-centering chucks MADE IN ITALY



DIN
6350

Standard equipment: 1 set made by 3 internal clamp jaws, 1 set made by 3 external clamp jaws, 1 chuck wrench for jaws opening

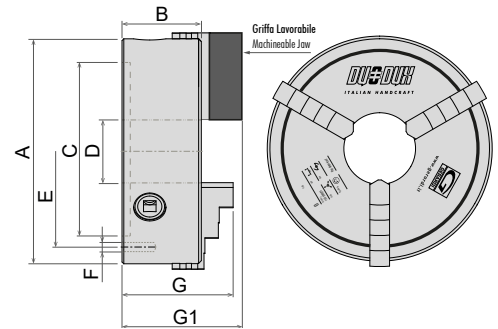
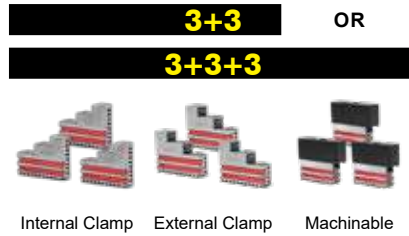

	A	B	C h6	D	E	F	G	G1	daN	Rpm
SINGLE GUIDE	Ø160	70,5	130	42	144,5	N°3 M8	89,5	106	3.100	Max 3.600
DOUBLE GUIDE	Ø200	81	160	53	176	N°3 M10	113	132,5	3.700	Max 3.000
DOUBLE GUIDE	Ø250	88,5	200	80	224	N°6 M12	124	149,5	4.600	Max 2.500
DOUBLE GUIDE	Ø310	100,5	260	108	286	N°3 M12	143,5	162,5	5.500	Max 2.000
DOUBLE GUIDE	Ø365	105,5	310	126,5	336,5	N°6 M14	155	168	5.900	Max 1.800
DOUBLE GUIDE	Ø430	114	382	170	405	N°6 M14	170	176,5	6.900	Max 1.400

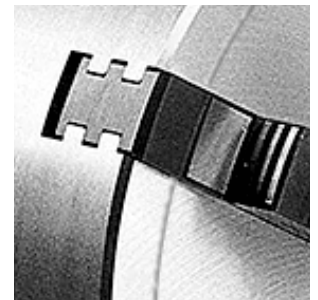

3+3					3+3+3				
	A	Kg	Cod.	LIST PRICE €	SPECIAL PRICE €	Kg	Cod.	LIST PRICE €	SPECIAL PRICE €
SINGLE GUIDE	Ø160	8	GMD-160-3G20	1.067	854	10	GMD-160-3G30	1.333	1.066
DOUBLE GUIDE	Ø200	15	GDD-200-3G20	1.156	925	18	GDD-200-3G30	1.444	1.155
DOUBLE GUIDE	Ø250	23	GDD-250-3G20	1.358	1.086	27	GDD-250-3G30	1.650	1.320
DOUBLE GUIDE	Ø310	38	GDD-310-3G20	1.984	1.587	44	GDD-310-3G30	2.319	1.855
DOUBLE GUIDE	Ø365	61	GDD-365-3G20	3.092	2.474	71	GDD-365-3G30	3.760	3.008
DOUBLE GUIDE	Ø430	92	GDD-430-3G20	4.345	3.476	103	GDD-430-3G30	5.180	4.144



ACCURACY, RIGIDITY & STABILITY ALSO DURING HEAVY DUTY MACHINING

DUO-DUX, the double guide self-centering manual chuck 100% Made in Italy. It is made with double guided integral jaws, which can stand heavier charges and grant a better stability. The crown is ground with a special way studied by Gerardi to grant highest precision and repeatability. Every DUO-DUX chuck is balanced following the ISO3089/74 rules and supplied with the warranty and testing certificates. The chucks with diameter 365 and 430mm, suitable for heavy-duty machinings, keep the same technical features and precision of the chucks with lower diameters.

HIGHEST RIGIDITY

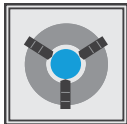

5 YEARS GUARANTEED



IRON CAST BODY



Special model
Ø270-105

Not only standard dimensions: a special Ø270mm version with increased bar holder Ø105 is available too.
Code GDD-270-3G20-105



Integral Jaws

Integral clamping jaws are made of hardened nichel-chrome steel for the highest accuracy and repeatability.



Double guide

Double guide system of our Duo Dux self-centering vises can bear higher workload and grant a higher stability.



5 Years Warranty

Sure of the reliability and high quality of all self-centering vises DuoDux components, we recognize 5 years warranty on the whole range.

STATIC TOOL HOLDERS

A wide range of driven tools with an unbeatable price / quality ratio



SCAN THE QR CODE AND CHOOSE FROM A WIDE RANGE ON THE CATALOGUE

DIN 69880

DMG MORI

Mazak

LOKUMA

BMT

Bolt Mounted Turret



Nakamura-Tome



TSUGAMI CORPORATION

Ask the password to your supplier

EXAMPLE KIT 1

3 PCS

REDUCTION UP TO
10%

EXAMPLE KIT 2

4 PCS

REDUCTION UP TO
15%

PURCHASING 3 STATIC TOOLS

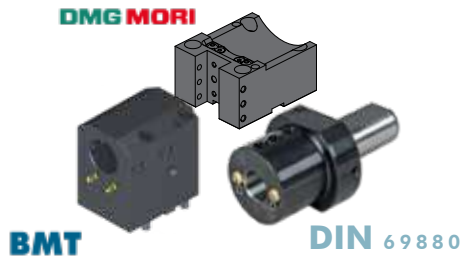

PURCHASING 3 STATIC TOOLS

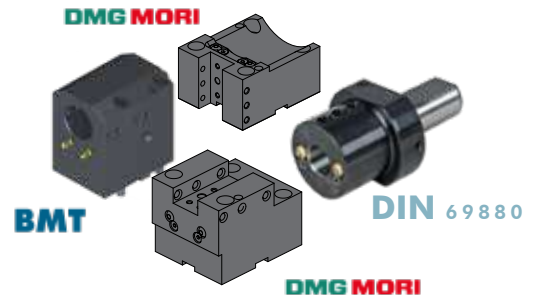

THE DRIVEN TOOL FOR YOUR LATHE

A quick overview of manufacturers on which all our Driven Tools can be mounted.

T05 pages	Manufacturer	Turret	T05 pages	Manufacturer	Turret	T05 pages	Manufacturer	Turret	T05 pages	Manufacturer	Turret		
From Page 4.11 to Page 4.44	DIN 5480	VDI	From Page 5.49 to Page 5.51	DOOSAN	BMT 65	From Page 5.55 to Page 5.69	DMG MORI	NL NLX	From Page 5.109 to Page 5.118	MIYANO	Ø38		
	DIN 5482			Goodway			DMG MORI	Goodway		Ø45			
	BARUFFALDI			Haas			Takisawa Japan	MIYANO		Ø 54			
	DIN 1809			Hardinge			DMG MORI	NAKAMURA		BMT 44			
From Page 5.21 to Page 5.32	BIGLIA	BMT 40		Hyundai WIA		Samsung	SL	From Page 5.122 to Page 5.125	Cmz	ZL DL	From Page 5.127 to Page 5.133	Muratec	BMT 44
	BMT 55	Hwacheon		Spinner		Goodway	G1		NAKAMURA	BMT 55			
		Victor		Victor		GOODWAY	G3		Cmz	BMT 65			
		Victor		Takisawa Taiwan		HAAS	G4		NAKAMURA	BMT 65			
From Page 5.33 to Page 5.39	DOOSAN	BMT 45		DOOSAN		BMT 75	From Page 5.75 to Page 5.78	GOODWAY	L= 104,85	From Page 5.127 to Page 5.133	OKUMA	VDI 30	
	Hardinge			Hwacheon					L= 117,55			VDI 40	
	Jyoti			Hyundai WIA					L= 130,25			BMT 55	
	Nexturn			Samsung					Victor			BMT 60	
From Page 5.40 to Page 5.44	Samsung	BMT 55	DOOSAN	BMT 85	From Page 5.79 to Page 5.90	HAAS	QTN 1 VDI 40	From Page 5.135 to Page 5.138	SPINNER	BMT45 SP			
	Victor		Hwacheon				QTN 2 VDI 40			VDI25 SP			
	Victor		Hyundai WIA				QTN 3 VDI 50			BARUFFALDI VDI 30			
	Takisawa Taiwan		Jyoti				QTS SMART BMT68			BARUFFALDI VDI 40			
From Page 5.91 to Page 5.106	DOOSAN	BMT 55	DOOSAN	BMT 85	From Page 5.91 to Page 5.106	MAZAK	HQ	From Page 5.149 to Page 5.156	TSUGAMI	BARUFFALDI VDI 50			
	Goodway		Hwacheon				QTS SMART BMT68			TAKISAWA JAPAN	BMT 60		
	Hardinge		Hyundai WIA				HQ			TAKISAWA TAIWAN	BMT 60		
	Hwacheon		Samsung							TSUGAMI	BMT 65		

DRIVEN TOOLS

Upgrade your lathe and boost productivity!

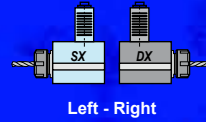

SCAN TO DISCOVER HIGH PERF. TYPE

HIGH PERFORMANCE MODELS AVAILABLE (+ TORQUE, + RPM)



Which is your machine model?

WE BET IT IS ON OUR ESTORE !

- 1 What brand and model of lathe are you looking for ?
DOOSAN / HARDINGE / GOODWAY / DMG MORI / MIYANO ecc...
- 2 Which kind of turret has your lathe?
VDI / BMT55 / BMT65 ecc...



Check out our estore, with two simple questions you will find all the Driven Tools suitable for the lathe you have !

💧 Int. Coolant
 🔄 Direction of rotation same as machine spindle
 🔄 Direction of rotation opposite to machine spindle
 🔄 Both direction of rotation to machine spindle available

* The torque value, expressed in Nm, is the maximum allowed. Prolonged use at this value can damage the driven tool; for longer life and less wear, it is recommended to keep it below this limit.

BMT (Bolt Mounted Turret)

COMPATIBLE WITH DOOSAN / HARDINGE / SAMSUNG / HWACHEON / HYUNDAI WIA / VICTOR / HAAS / SPINNER. BMT 65 ALSO COMPATIBLE WITH HAAS LATHES!

Tipo Type	BMT	Cod.	ER	H Max	Nm*	Rpm	LIST PRICE €	SPECIAL PRICE €
Axial	45	99.DS.A03	25	57,2	35	8000	1.033	839
Axial	45	99.DS.A04	25	57,2	35	8000	1.179	929
Axial	55	99.DS.A01	25	57,2	40	8000	1.243	899
Axial	55	99.DS.A02	25	57,2	40	8000	1.363	979
Axial	65 HAAS READY!	99.DS.A41	32	72,5	70	6000	1.274	1.049
Axial	65 HAAS READY!	99.DS.A42	32	72,5	70	6000	1.465	1.179
Axial	75	99.DS.A34	40	90,2	100	6000	1.497	1.249
Axial	75	99.DS.A35	40	90,2	100	6000	1.720	1.399
Radial	45	99.DS.A07C	25	65	35	8000	1.822	1.499
Radial	45	99.DS.A08C	25	65	35	8000	2.190	1.799
Radial	55	99.DS.A11C	25	70	40	8000	2.038	1.599

Tipo Type	BMT	Cod.	ER	H Max	Nm*	Rpm	LIST PRICE €	SPECIAL PRICE €
Radial	55	99.DS.A12C	25	70	40	8000	2.408	1.899
Radial	65 HAAS READY!	99.DS.A51C	32	72	70	6000	2.140	1.699
Radial	65 HAAS READY!	99.DS.A52C	32	72	70	6000	2.534	1.999
Radial	65 HAAS READY!	99.DS.A73C	32	100	70	6000	2.310	1.899
Radial	65 HAAS READY!	99.DS.A74C	32	100	70	6000	2.711	2.199
Radial	75	99.DS.A38C	40	60	100	6000	3.311	2.649
Radial	75	99.DS.A39C	40	60	100	6000	3.973	3.099
Adj ±90°	45	99.DS.A16	20	65	15	8000	4.698	3.899
Adj ±90°	45	99.DS.A17	20	65	15	8000	6.111	4.699
Adj ±90°	55	99.DS.A23	20	65	15	8000	4.698	3.899
Adj ±90°	55	99.DS.A66	20	65	15	8000	6.111	4.699
Adj ±90°	65 HAAS READY!	99.DS.A64	25	75	25	6000	5.221	4.299
Adj ±90°	65 HAAS READY!	99.DS.A65	25	75	25	6000	6.748	5.199
Adj ±90°	75	99.DS.A47	25	75	25	6000	5.221	4.299
Adj ±90°	75	99.DS.A48	25	75	25	6000	6.748	5.199

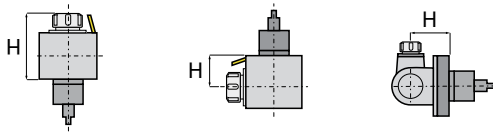

BMT ATTACHMENT WITH STANDARD TENON

Code example with Bigger Tenon: **99.DS.A03T**

Driven tools with **bigger tenon** available on request

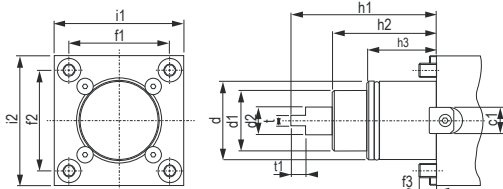

BMT	c1	d	d1	d2	f1	f2	f3	h1	h2	h3	i1	i2	t	t2	h4	N	ØM
45	15	Ø45	35	14	58	58	10	84	60	40	75	75	6	8,5	-	-	-
55	15	Ø55	40	16	64	64	14	104	75	30	85	85	8	8,5	9,5	8	29
65	18	Ø65	45	18	70	73	15	112	83	32	94	94	10	14	15	10	29
75	25	Ø75	55	23	90	90	15	110	80	43	112	112	14	15	-	-	-
85	25	Ø85	65	33,5	100	100	18	140	100	43	125	125	16	20	-	-	-

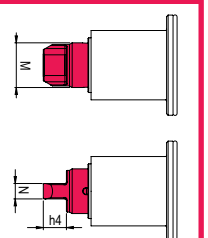

DRIVEN TOOLS

Upgrade your lathe and boost productivity!

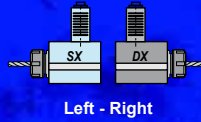

SCAN TO DISCOVER HIGH PERE. TYPE

HIGH PERFORMANCE MODELS AVAILABLE (+ TORQUE, + RPM)



● Int. Coolant
 ↻ Direction of rotation same as machine spindle
 ↻ Direction of rotation opposite to machine spindle
 ↻ ↻ Both direction of rotation to machine spindle available
 * The torque value, expressed in Nm, is the maximum allowed. Prolonged use at this value can damage the driven tool; for longer life and less wear, it is recommended to keep it below this limit.

DIN 5480 / 5482

VDI - DIN69880
 * In case of order specify always left or right orientation you need

Type	VDI	Cod.	ER	H	* Nm	Rpm	LIST PRICE €	SPECIAL PRICE €
Axial	30	99.ST.8003	25	66	32	6000	917	779
Axial	30	99.ST.8011	25	66	32	6000	1.185	979
Axial	40	99.ST.8005	32	95	63	6000	1.147	999
Axial	40	99.ST.8013	32	95	63	6000	1.499	1.229
Radial	30	99.ST.8030	25	55	32	6000	1.926	1.599
Radial	30	99.ST.8038	25	55	32	6000	2.216	1.829
Radial	30	99.ST.8031	25	85	32	6000	2.018	1.699
Radial	30	99.ST.8032	25	100	32	6000	2.056	1.749
Radial	30	99.ST.8039	25	85	32	6000	2.302	1.999
Radial	30	99.ST.8040	25	100	32	6000	2.784	2.399
Radial	40	99.ST.8033	32	100	63	6000	2.436	1.999
Radial	40	99.ST.8041	32	100	63	6000	2.798	2.299
Axial	30	99.ST.8201	25	94	32	6000	865	779
Axial	30	99.ST.8207	25	94	32	6000	1.161	979
Axial	40	99.ST.8203	32	115	63	5000	1.041	899
Axial	40	99.ST.8208	32	115	63	5000	1.347	1.129
Radial	30	99.ST.8217	25	55	32	6000	1.735	1.449
Radial	30	99.ST.8223	25	55	32	6000	2.025	1.699
Radial	40	99.ST.8220	32	100	63	5000	2.078	1.699
Radial	40	99.ST.8226	32	100	63	5000	2.430	1.999

BARUFFALDI

VDI - DIN69880
 * In case of order specify always left or right orientation you need

Axial	30	99.BF.0003	25	94	32	6000	895	779
Axial	30	99.BF.0010	25	94	32	6000	1.193	979
Axial	40	99.BF.0005	32	117	63	5000	1.079	929
Axial	40	99.BF.0011	32	115	63	5000	1.391	1.179
Radial	30	99.BF.0021	25	55	32	6000	1.781	1.499
Radial	30	99.BF.0027	25	55	32	6000	2.086	1.749
Radial	40	99.BF.0024	32	100	63	5000	2.140	1.749
Radial	40	99.BF.0030	32	100	63	5000	2.506	2.049

DIN 1809

VDI - DIN69880
 * In case of order specify always left or right orientation you need

Axial	30	99.DP.0903	25	94	32	6000	865	779
Axial	30	99.DP.0910	25	94	32	6000	1.161	979
Axial	40	99.DP.0905	32	115	63	5000	1.041	879
Axial	40	99.DP.0911	32	115	63	5000	1.347	1.129
Radial	30	99.DP.0919	25	55	32	6000	1.735	1.449
Radial	30	99.DP.0925	25	55	32	6000	2.025	1.699
Radial	40	99.DP.0922	32	100	63	5000	2.078	1.699
Radial	40	99.DP.0928	32	100	63	5000	2.430	1.999

BIGLIA

NICKEL PLATING SOLID BODY
 BMT55: B301 / 445 / 455 / 470 / 501 (Y-S) 510 / 545 / 550 / 565 / 650 / 658 / 1200 / 446 / 465 / 745 / 765 / B750 / 1250 16 STATIONS

Type	BMT	Cod.	Biglia Code	ER	H	* Nm	Rpm	LIST PRICE €	SPECIAL PRICE €
Axial	55	99.BG.A01	10.57.88.00	25	70	47	6000	887	699
Axial	55	99.BG.A02	T.134-00061	32	70	47	6000	887	699
Axial	55	99.BG.A03	T.134-00071	32	70	47	6000	1.227	949
Radial	55	99.BG.A05	10.57.87.00	25	70	47	6000	1.661	1.249
Radial	55	99.BG.A06	T.134-00062	32	70	47	6000	1.661	1.249
Radial	55	99.BG.A07	T.134-00072	32	70	47	6000	2.179	1.649
Radial	55	99.BG.A08	T.134-00076	25	100	47	6000	1.868	1.399
Radial	55	99.BG.A09	T.134-00077	32	100	47	6000	1.868	1.399
Radial	55	99.BG.A10	T.134-00088	32	100	47	6000	2.179	1.649
Adj ±90°	55	99.BG.A15	T.134-00025	16	60	16	6000	3.830	2.849
Adj ±90°	55	99.BG.A16	T.134-00057	20	60	16	6000	3.830	2.849

DMGMORI

SL/ZL 150, 153, 154 (MC / SMC / Y / SY)
 DL 15, 150 (MC)
 NLX 1500 - 2000 - 2500 - 3000 12 Posizioni
 NZ 1500 - 2000 - 3100 - 3150 - 3200 16 Posizioni

Type	Cod.	ER	H Max	* Nm	Rpm	LIST PRICE €	SPECIAL PRICE €
Axial	99.MS.A28	32	55,5 +60	70	6000	1.337	1.199
Axial	99.MS.A29	32	55,5 +60	70	6000	1.758	1.599
Radial	99.MS.A33	32	55	70	6000	2.102	1.899
Radial	99.MS.A34	32	55	70	6000	2.522	2.299
Axial	99.MS.A59	32	89,9	60	10.000	1.249	1.099
Axial	99.MS.A62	40	92	60	10.000	2.993	2.349
Axial	99.MS.A60	32	89,9	60	10.000	2.993	2.349
Axial	99.MS.A63	40	92	60	10.000	2.993	2.349
Radial	99.MS.A72	32	90	60	10.000	2.674	2.099
Radial	99.MS.A76	40	90	60	10.000	2.993	2.349
Radial	99.MS.A73	32	90	60	10.000	2.993	2.349
Radial	99.MS.A77	40	90	60	10.000	2.993	2.349
Axial	99.MS.A101	25	84,3	50	12.000	1.249	1.049
Axial	99.MS.A103	32	89,2	50	12.000	1.847	1.479
Axial	99.MS.A102	25	84,3	50	12.000	1.847	1.479
Axial	99.MS.A104	32	89,2	50	12.000	2.674	2.099
Radial	99.MS.A106	25	85	50	12.000	2.674	2.099
Radial	99.MS.A108	32	85	50	12.000	2.993	2.349
Radial	99.MS.A107	25	85	50	12.000	2.993	2.349
Radial	99.MS.A109	32	85	50	12.000	2.993	2.349

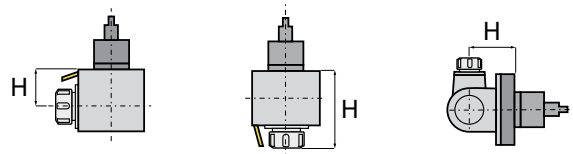

DRIVEN TOOLS

Upgrade your lathe and boost productivity!

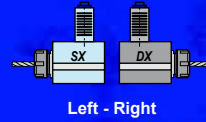

SCAN TO DISCOVER
HIGH PERF. TYPE

HIGH PERFORMANCE
MODELS AVAILABLE

(+ TORQUE, + RPM)



💧 Int. Coolant
 🔄 Direction of rotation same as machine spindle
 🔄 Direction of rotation opposite to machine spindle
 🔄 🔄 Both direction of rotation to machine spindle available
 * The torque value, expressed in Nm, is the maximum allowed. Prolonged use at this value can damage the driven tool; for longer life and less wear, it is recommended to keep it below this limit.

HAAS



* Interchangeable couplings for any type of Haas turret

Type	Cod.	ER	H Max	h1	* Nm	Rpm	LIST PRICE €	SPECIAL PRICE €
Axial	99.HA.590082	32	75	117,5	63	6000	945	749
Axial	99.HA.590082B	32	75	117,5	63	6000	1.179	899
Axial	99.HA.590083	32	75	104,8	63	6000	945	749
Axial	99.HA.590083B	32	75	104,8	63	6000	1.179	899
Axial	99.HA.596352	32	75	130,25	63	6000	945	749
Axial	99.HA.596352B	32	75	130,25	63	6000	1.179	899
Radial	99.HA.590084	32	75	117,5	63	6000	1.773	1.349
Radial	99.HA.590084B	32	75	117,5	63	6000	2.240	1.699
Radial	99.HA.590085	32	75	104,8	63	6000	1.773	1.349
Radial	99.HA.590085B	32	75	104,8	63	6000	2.240	1.699
Radial	99.HA.596353	32	75	130,25	63	6000	1.773	1.349
Radial	99.HA.596353B	32	75	130,25	63	6000	2.240	1.699

MAZAK

QTN3 QUICK TURN NEXUS QTN 300 / 350 / 400 / 450 - SQT 28 / 30 - 300 - QTN2 12 Posizioni QUICK TURN NEXUS QTN 200 / 250 SUPER QUADREX TURN SQT 15/18 - 200 / 250 - SMART QTS1 - BMT68 QUICK TURN SMART QTS 100M / 200M QT COMPACT 100M - 200M - 300M

Type	Cod.	ER	H	* Nm	Rpm	LIST PRICE €	SPECIAL PRICE €
Off. Axis	99.MZ.A71	40	145	100	4000	3.320	3.100
Off. Axis	99.MZ.A72	40	145	100	4000	3.631	3.342
Radial	99.MZ.A75	40	160	100	4000	3.424	3.200
Radial	99.MZ.A81	40	160	100	4000	3.943	3.649
Off. Axis	99.MZ.A58	32	120	80	6000	2.491	1.549
Off. Axis	99.MZ.A59	32	120	80	6000	3.010	2.100
Radial	99.MZ.A65	32	120	80	6000	2.698	1.649
Radial	99.MZ.A66	32	120	80	6000	2.906	1.949
Axial	99.MZ.A03	32	70	60	6000	1.972	1.849
Axial	99.MZ.A06	32	70	60	6000	2.387	2.199
Radial	99.MZ.A09	32	80	60	6000	2.698	2.499
Radial	99.MZ.A10	32	80	60	6000	2.906	2.799

MIYANO

Ø 45: WT100 - TW1
Ø 54: WT100 - TW1

Type	Ø	Cod.	ER	H Max	* Nm	Rpm	LIST PRICE €	SPECIAL PRICE €
Axial	45	99.MY.A02	25	57,6	35	6000	853	749
Axial	45	99.MY.A03	25	57,6	35	6000	1.022	899
Axial	54	99.MY.A09	32	79,4	60	6000	993	849
Axial	54	99.MY.A10	32	79,4	60	6000	1.140	949
Radial	45	99.MY.A05	25	65	35	6000	1.506	1.249
Radial	45	99.MY.A06	25	65	35	6000	2.456	1.749
Radial	54	99.MY.A11	32	75	60	6000	2.284	1.899
Radial	54	99.MY.A12	32	75	60	6000	2.207	1.849

NAKAMURA-TOME

BMT44 WT100 - TW1
BMT55 SUPER NTJ-NTJX/NTM 3/TMC 18/ TW10/SC150-250/WT150-250/WTW 150/WTS 150/WT100

Type	BMT VDI	Cod.	ER	H Max	* Nm	Rpm	LIST PRICE €	SPECIAL PRICE €
Axial	45	99.NK.A40	25	57,2	40	6000	946	799
Axial	45	99.NK.A43	25	57,2	40	6000	1.081	899
Axial	55	99.NK.A03	32	72,2	63	6000	993	849
Axial	55	99.NK.A04	32	72,2	63	6000	1.530	1.299
Radial	45	99.NK.A50	25	60	40	6000	1.676	1.399
Radial	45	99.NK.A53	25	60	40	6000	2.008	1.699
Radial	55	99.NK.A13	32	55	63	6000	1.868	1.549
Radial	55	99.NK.A14	32	55	63	6000	2.519	2.099

OKUMA

BMT60: SPACE TURN LB 200EX/LB 2500EX/LB3000EX/GENOS SERIES L300-MW/ MULTUS U3000/U40007/LU3000EX M/MY VDI40: OKUMA CAPTAIN L370 M - ES L10 M - GENOS L300, L3000-E M/MY (VDI40) LB 300 MW - LB/LU 300 MY - LB/LU 300, 3000 M (VDI40)

Axial	60	99.OK.A80	32	79	60	6000	1.687	1.299
Axial	60	99.OK.A81	32	79	60	6000	2.141	1.599
Radial	60	99.OK.A82	32	70	60	6000	3.048	2.299
Radial	60	99.OK.A83	32	70	60	6000	3.631	2.749
Axial	40	99.OK.A18	32	98,6	70	6000	1.947	1.499
Axial	40	99.OK.A23	32	98,6	70	6000	2.465	1.899
Radial	40	99.OK.A19	32	70	60	6000	3.373	2.549
Radial	40	99.OK.A25	32	70	60	6000	4.151	3.149

TAKISAWA TAIWAN

BMT60 EX 380 / 310 / 508 / 510 / 708 / 710 / 910 - EX 2000 M/Y - TC 350 MC - TT 350 MC - NEX 108/110/908/910 - LA 200/250 M/Y - LA 250 YS (15 stations) - FX 800 - MX 800 - VTL 450 M - LX 2500 M/Y

Type	BMT	Cod.	ER	H	* Nm	Rpm	LIST PRICE €	SPECIAL PRICE €
Axial	60	99.TK.A12	32	93	50	6000	1.499	1.149
Axial	60	99.TK.A13	32	93	50	6000	2.213	1.699
Radial	60	99.TK.A02	32	90	50	6000	3.139	2.399
Radial	60	99.TK.A05	32	90	50	6000	3.333	2.549

TSUGAMI

BMT65: M06D / M06SD / M06SY / M08SD / M08SY

Type	BMT	Cod.	ER	H Max	* Nm	Rpm	LIST PRICE €	SPECIAL PRICE €
Axial	65	99.TS.A01	25	60	40	8000	1.558	1.199
Axial	65	99.TS.A03	32	60	40	8000	2.141	1.649
Axial	65	99.TS.A02	25	60	40	8000	2.529	1.949
Axial	65	99.TS.A04	32	60	40	8000	3.112	2.449
Radial	65	99.TS.A08	25	65	40	8000	2.529	1.949
Radial	65	99.TS.A10	32	65	40	8000	3.112	2.449
Radial	65	99.TS.A09	25	65	40	8000	3.112	2.449
Radial	65	99.TS.A11	32	65	40	8000	3.112	2.449

MAGNETIC CHUCKS WITH SQUARE POLE

Electro-permanent system for milling operations

The Gerardi magnetic chuck offers powerful and precise magnetic clamping, optimizing setup time and increasing productivity. It is the ideal solution for clamping on machine tools in a safe and energy-efficient manner. Available with 50 and 75 poles, it is ideal for milling and other operations



TECHNICAL FEATURES & ADVANTAGES

- Uniform clamping**
- Totally free working surface**
- Easy to use**
- Elimination of machining vibration**
- Energy saving**
- Maximum safety**
- Quick workpiece setup and removal**
- Better finishing grade**
- Reduced tools consumption**
- Little maintenance compared to conventional clamping systems**

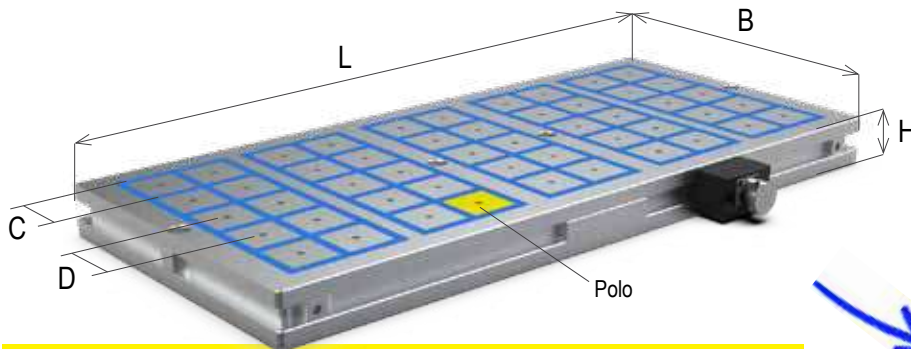
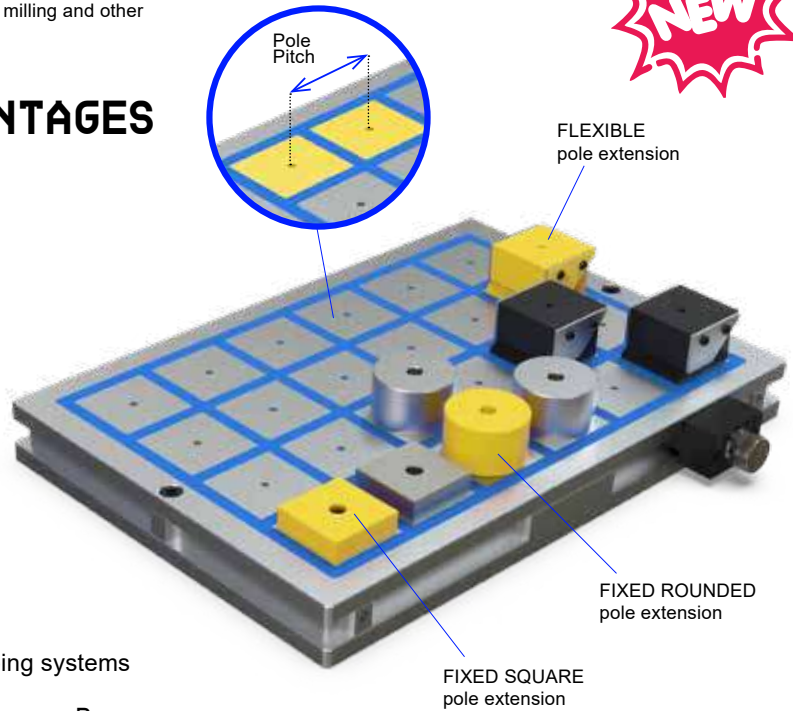

SOON ALSO AVAILABLE WITH P75 AND PITCH 88

POLE 50
ART. 89P-50

B	C	D	H	L	Kg	Poli Poles	Prot Kg	Art.89P (50) Per GHISA/ACCIAIO	LIST PRICE €	PREZZO OFFERTA €
360	50	60	55	360	57	25	10.000	89P5363625	2.550	1.999
370	50	60	55	635	90	40	16.000	89P5376340	4.100	3.199
360	50	60	55	790	108	50	20.000	89P5367950	5.100	3.999
580	50	60	55	940	200	96	38.400	89P5589496	9.800	7.499



Thanks to the Microprocessor Controller is possible operate quickly and easily with one or multiple magnetic plates at the same time.

MAGNETIC CHUCK

Precision Modular vises matchable for gang operations and pneumohydraulic clamping (StandardMatic series)

MORE VERSATILITY

The Electropermanent system easily adapts to pieces of various geometries and complexities.

MILLING OPERATIONS

This is the only magnetic chuck that will not loose force when the part is machines at a distance from the magnetc chuck.

2 YEARS WARRANTY

EXPIRES ON 31.07.25

MADE in ITALY



GERARDI SPA

via Giovanni XXIII, 101 - 21015 LONATE POZZOLO (VA) Italia - Tel. +39.0331.303911 - Fax +39.0331.301534
gerardi@gerardispa.com - www.gerardi.it